

012.042 (6.60m)

- ┌ 002.052 └ 002.225
- └ 003.300 └ 003.300
- └ 003.301 └ 003.301
- └ 003.414 └ 003.414

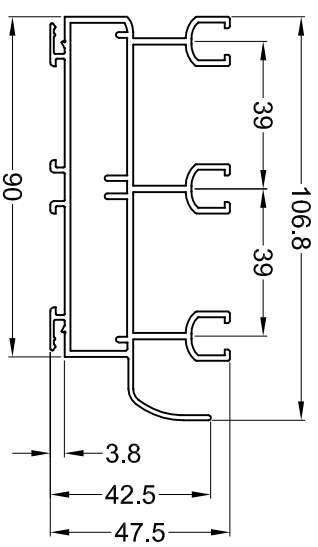

012.043 (6.60m)

- ┌ 002.052 └ 002.225
- └ 003.300 └ 003.300
- └ 003.301 └ 003.301
- └ 003.414 └ 003.414

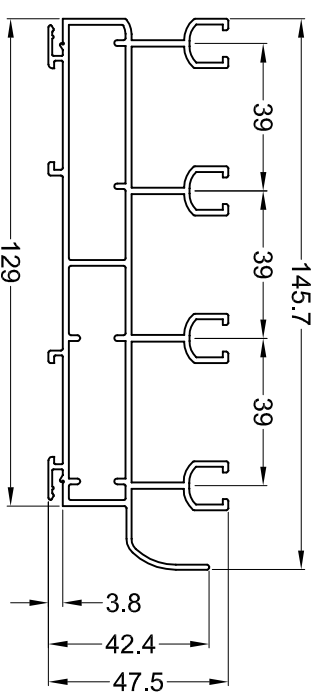

012.044 (6.60m)

- ┌ 002.225
- └ 003.300
- └ 003.301
- └ 002.211

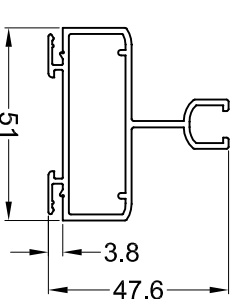

012.064 (6.60m)

- ┌ 002.225
- └ 003.300
- └ 003.301
- └ 002.211

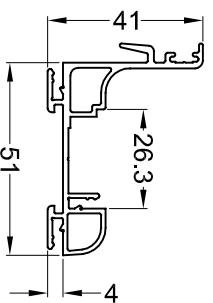

012.063 (6.60m)

SEUILS - CAPOT

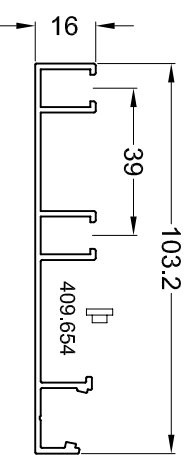

012.052

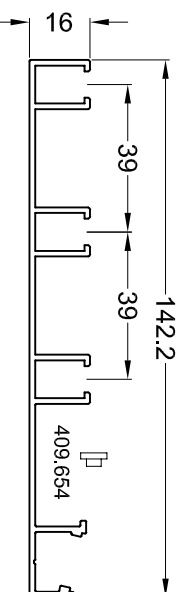

012.053

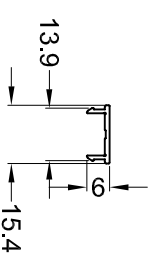

311.412 (7.00m)



PROFILS
COULISSANT
SERIE 012E



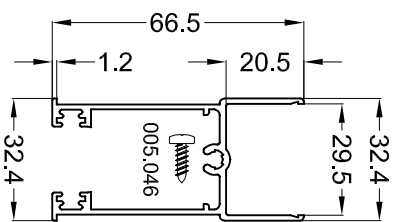

012.117 (5.00m)

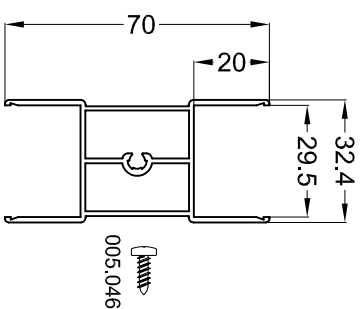

012.125 (5.00m)

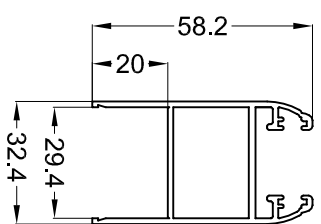

012.215 (4.50m)

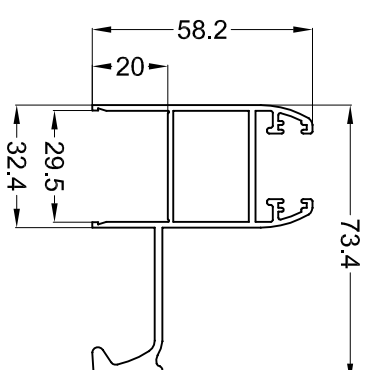

012.224 (5.00m)

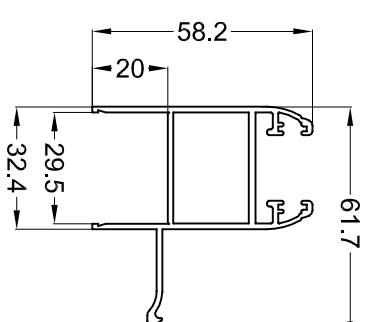

012.225 (4.50m)

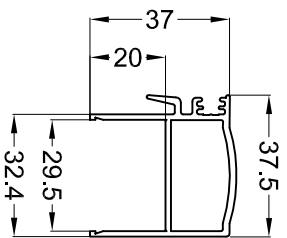

012.315 (4.50m)

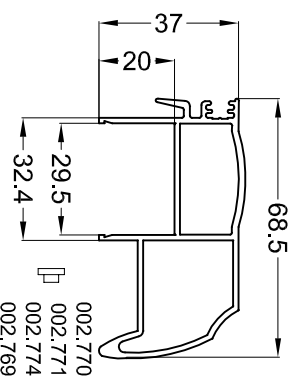

012.325 (4.50m)

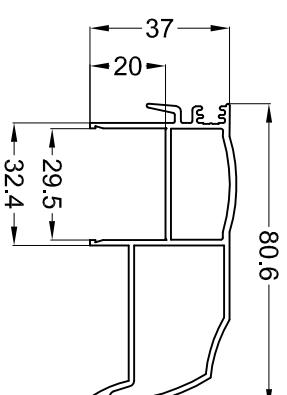

012.335 (5.00m)

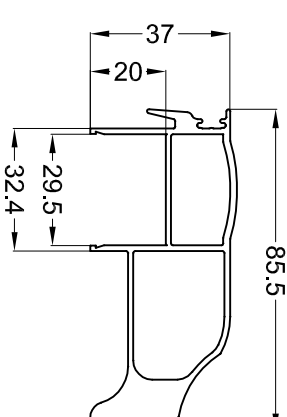

012.334 (5.00m)

PROFILS COMPLEMENTAIRES

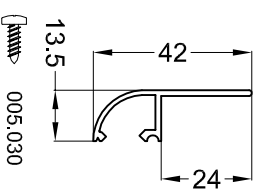

012.040

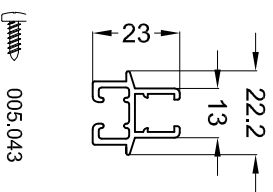

212.230 (4.50m)

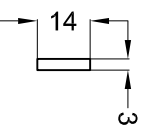

010.027

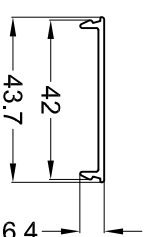

311.016

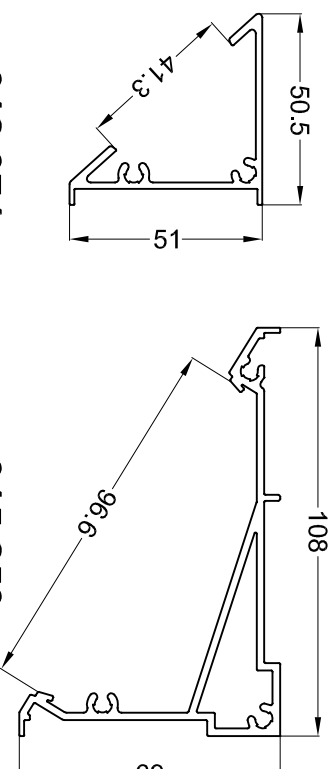

012.074

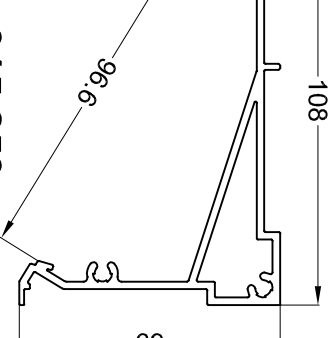

015.250

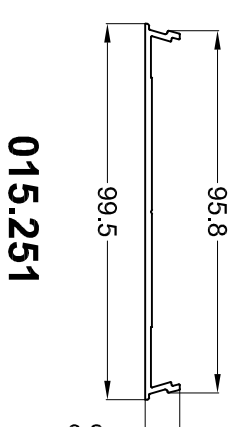

015.251

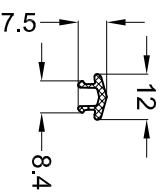

019.056

RAIL RAPPORTE
POLYAMIDE NOIR

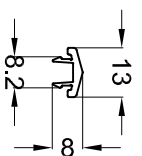

019.058

RAIL ALUMINIUM RAPPORTE

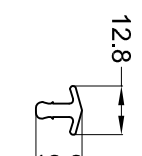

019.059

RAIL ALUMINIUM

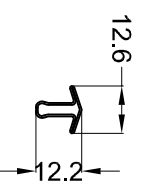

019.060

RAIL INOX

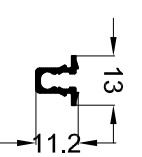

019.061

JOINT DE POSE

PROFILS
SYSTEMES

PROFILS
COULISSANT
SERIE 012E

